









IMO Bath spout for wall mounting - Brushed Platinum

IMO

13 801 670 Product version from 4/1/2024



- 200mm projection
- rectangular normal flow
- hole diameter 37 mm
- 1/2" connection
- max. flow 25.1 l/min at 3 bar flow pressure
- WRAS

	Brushed Platinum	13 801 670-06
	Chrome	13 801 670-00
	Dark Chrome	13 801 670-19
	Brushed Light Gold (PVD)	13 801 670-27
	Matte Black	13 801 670-33
	Brushed Gold (PVD)	13 801 670-37
	Brushed Chrome	13 801 670-93
	Brushed Dark Platinum	13 801 670-99

Recommended miscellaneous



Concealed wall elbow -

- max. recess depth 163 mm
- min. recess depth 90 mm

35 085 970 90

13 801 670 Product version from 4/1/2024

mm [inches]

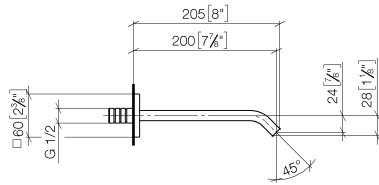

Flow rate chart

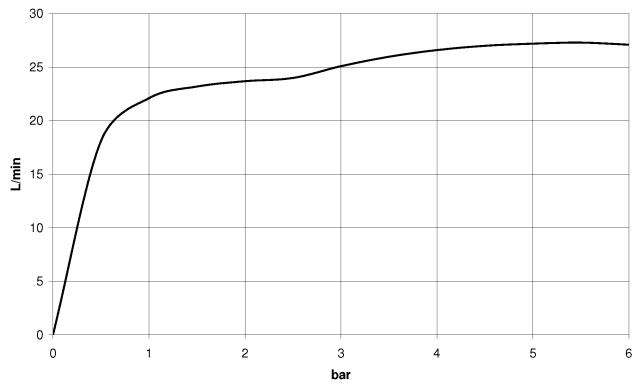

Codes & Standards

ASME A112.18.1

cUPC

Scottish Water
Byelaws

UK Water Supply
Regulations



IMO Bath spout for wall mounting - Brushed Platinum

IMO

13 801 670 Product version from 4/1/2024

Certificates and sustainability

IAPMO_4976	WRAS_2005	EPD-DOR-20230287 -IBA1-EN Environmental.prod uct-declarat
------------	-----------	--

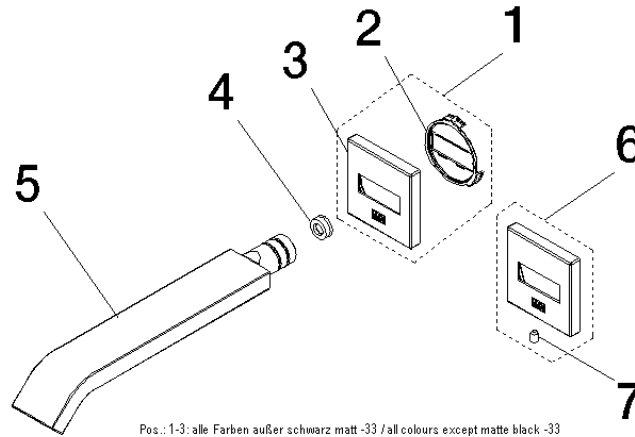

Pos.: 1-3: alle Farben außer schwarz matt -33 / all colours except matte black -33
 Pos.: 6-7: nur Farbe schwarz matt -33 / only colour matte black -33

Spare parts list

No.	Item Number	Name	Quantity used	Delivery time
2	09 18 40 139 90	base	1.00	2
7	09 31 11 058 90	pin	1.00	2
5	04 28 22 241 00-06	spout	1.00	10
4	09 23 01 057 90	flow reducer	1.00	2
1	90 27 67 008 00-06	rosette	1.00	-
Spare part can no longer be ordered, please order the replacement item				
3	09 27 67 008-06	rosette	1.00	10
6	90 27 97 050 00-33	rosette	1.00	-
Spare part can no longer be ordered, please order the replacement item				